

///TW Workholding

N.A. Woodworth Workholding Product Line

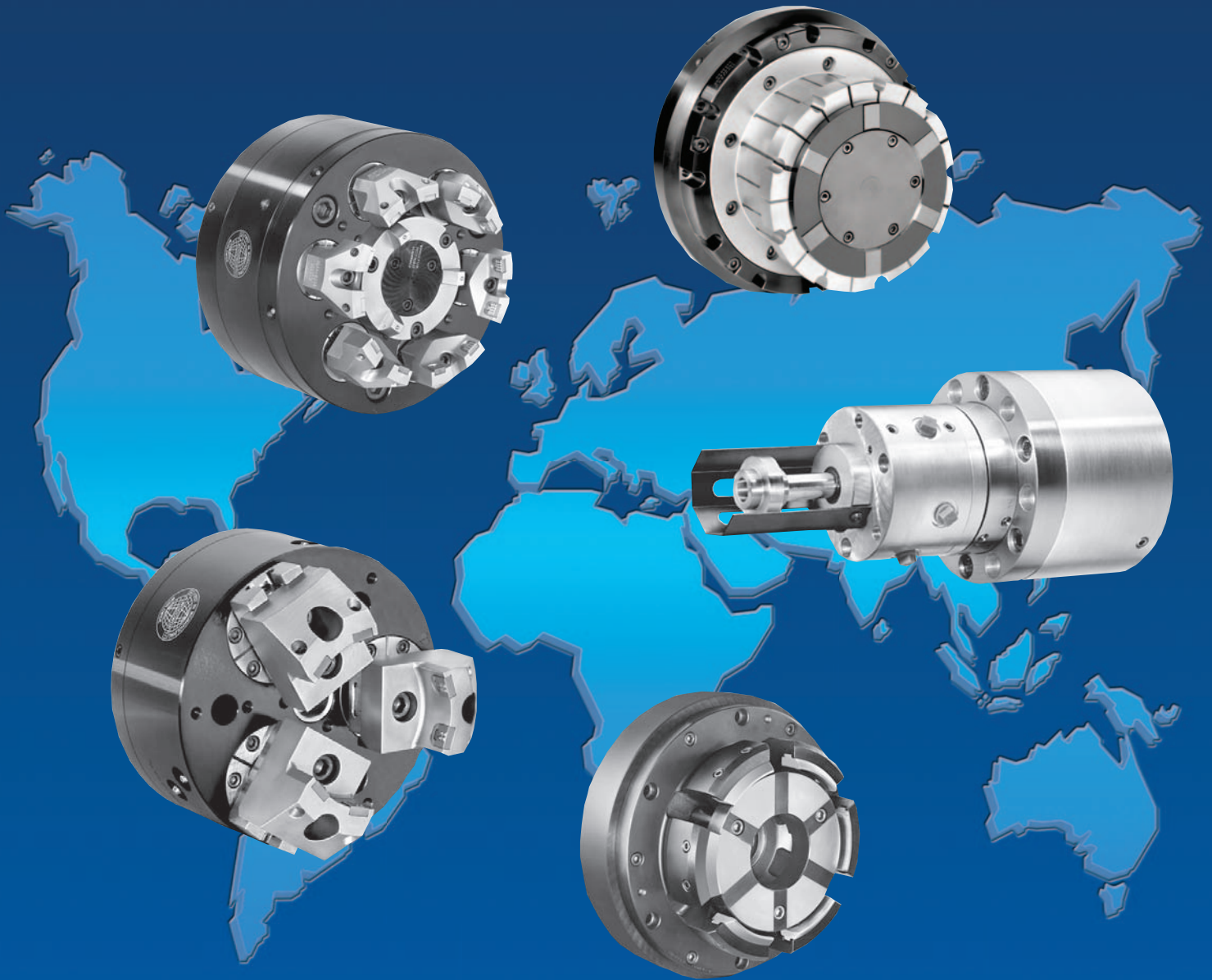

WORKHOLDING WORLDWIDE



Universal Ball-Lok Chucks

N.A. Woodworth's Universal Ball-Lok chucks have set the standard for all other power chucks in the industry. The "UBL" chuck's unique design can accommodate both centralizing and compensating operations.

- Internal and External Chucking
- Positive Pullback
- 2 and 3 Jaw Models
- Sealed Design
- Available with Quick-Change Jaws
- Sizes 6" to 30"



6-Jaw ECC Ball-Lok Chucks

N.A. Woodworth introduces a new twist on the industry leading UBL power chuck. This six-jaw design incorporates a new counter-centrifugal mechanism that allows the chuck to rotate at higher speeds with minimal jaw force loss. Additional features include:

- 12 Points of Equalized Force Distribution
- High RPM capability
- Completely Sealed Design
- Increased Output Sensitivity for Thin Wall Applications
- Differential Chucking Capabilities (use with ITW variable port cylinder)
- Centralizing and Compensating Models
- O.D. and I.D. Versatility

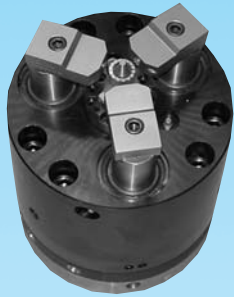

Retractable Work Driver Chucks

N.A. Woodworth's Retractable Work Driver (RWD) chucks offer the industry a unique and highly productive solution for shaft turning requirements. The RWD chuck enables continuous, uninterrupted turning over the entire length of the workpiece.

- Concentricity of .001 T.I.R.
- Speeds of up to 4000 RPM
- Positive End Driving
- Sealed Design
- Jaw Retraction During Rotation



Sliding Jaw

ITW Workholding has a full line of sliding jaw power chucks. The QLC (shown) is the latest in a range of performance power chucks from Forkardt that combine an improved backlash free wedge hook system with advanced features. Also offered are the Forkardt FNC and the SP Counter Centrifugal (CC). Each has unique features you should consider.

Forkardt QLC Features

- Variations include thru-hole and long stroke
- Centrifugal force compensation allowing for higher speeds
- Quick change jaw system available
- Patented force lubrication for extended service

Forkardt FNC Features

- Quick change master jaw
- Designed for higher speeds
- Nitrided chuck body
- Wedge hook design allowing for high grip force

SP Counter Centrifugal (CC)

- 2 and 3 jaw designs
- Light weight, counter centrifugal for higher speeds
- Dual use as a collet chuck, via collet pads

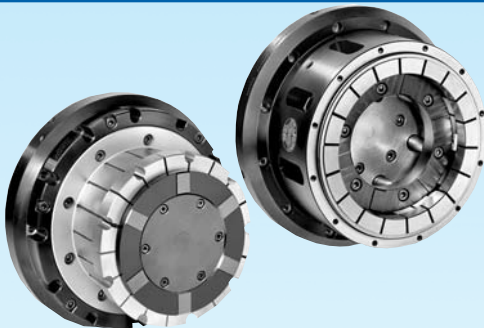

I.D. / O.D. Rim-Lok Collet Chucks

ITW Workholding offers an extensive line of Sheffer performance I.D. and O.D. Collet Chucks. These Sheffer engineered chucks can be designed to fit nearly any application — from roughing to grinding to stationary machine center work. Features include:

- Quick Change
- High Accuracy
- Interchangeability
- High Speed
- Master Inserts
- High Travel
- Self Contained Actuation
- Standard and Custom Designs

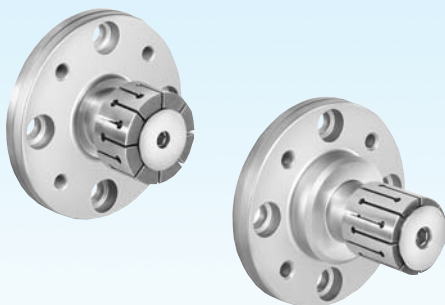

Tork-Lok Collets

The N.A. Woodworth Tork-Lok collet line offers flexibility and affordability, with much of the product available from stock. The Tork-Lok arbor locates straight or tapered holes on true center within .0005 T.I.R. These arbors feature patented inclined flats that provide full arbor/collet contact throughout the range of operation for highest accuracy and torque transmission.

- Offering several types of assemblies, the Tork-Lok line is ideally suited for turning and milling operations
- Standard operation is accomplished through the use of a drawbar to actuate the collet
- Several standard assembly designs exist, including:
 - Self Contained Air Operated Assembly, suited for turning and milling
 - Hand Operating Fixture, suited for milling, drilling, gear cutting or shaving, reaming and other operations
 - Standard Drawbar type, suited for mounting to special applications
- Collets can be sealed to eliminate the contaminants from interfering with functionality
- Design offers higher torque transmission due to design of inclined flats

Diaphragm / Pitch Line Chucks

ITW Workholding offers both traditional N.A. Woodworth and Sheffer style diaphragm chucks. These low maintenance, simple flexing devices hold high levels of precision on machined diameters. Built to last, these diaphragms offer a solution to secondary machining operations.

Features include:

- Dovetail, Master Jaw and Integral designs
- Positive pull back against locating surfaces
- Up to .0001 T.I.R. repeatability
- 3-6 jaw designs
- Standard designs available



Gear Diaphragms

Gear variability requires workholding that is flexible and allows for accuracy as well as reduced set-up time. ITW Workholding offers two diaphragm designs that meet those requirements, the Pitch Line (PLD, shown) and the Universal Gear (UG). Each are designed around the reliable N.A. Woodworth shell diaphragm concept. This design has proven its worth (and longevity!) across several industries. Both of these designs offer benefits to consider.

Pitch Line (PLD)

- Quick change jaw offers changeover in 60 seconds
- Accommodates any number of gear teeth
- Standard "pull-back" action
- Centrifugal force compensation for higher speeds

Universal Gear (UG)

- Standard design
- Gear range from 1" to 15"
- * Gear changeover in minutes

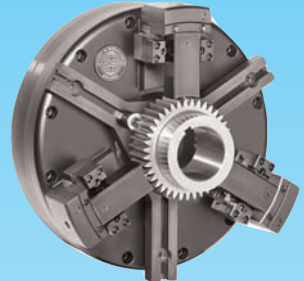

Stationary Workholding Solutions

N.A. Woodworth engineers custom prismatic workholding to meet mid to large volume production requirements. Whether your application requires tombstones, face-plates or unique actuation methods, our designs will provide you with accuracy, quality and simplicity.

- Right Angle Plates
- Multi-sided Tombstones
- Standard Quick Change Mounting Systems
- Modular Construction Design
- Self Contained Systems
- Hydraulic, Pneumatic and Manual Actuation
- Horizontal and Vertical Mill Applications

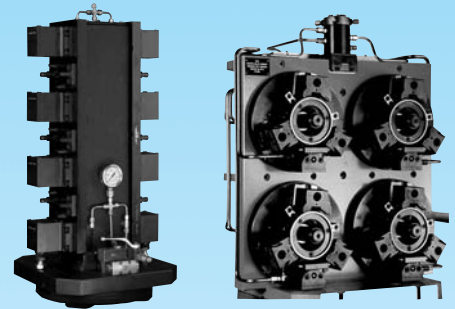

Tru-Change Couplings and Rings

ITW Workholding offers its Tru-Change rings as accessories and as mountings for our workholding. Manufactured and utilized in a wider variety of sizes and applications, the Woodworth Tru-Change ring can provide quick changeover with high repeatability, thereby providing the customer a viable lean solution.

- Capable of 5 micron repeatability
- High torsional load capacity
- Patented curved tooth design
- Self Centering and zero backlash
- Adaptable to any fixture or workholding device



Cylinders

ITW Workholding offers a line of standard pneumatic and hydraulic cylinders, featuring optimum speed and operating force. Utilizing the proven designs of Forkardt, Logansport as well as SP, ITW has a solution for your cylinder requirement. Standard features include:

- Prox switch or linear system stroke control
- Rear or front spindle mount configuration
- Thru-hole for coolant, air or oil with rotating union
- Up to 8,000 RPM
- Up to 80 bar max. operating force
- Thru hole design available
- Standard design with many sizes available from STOCK!!!

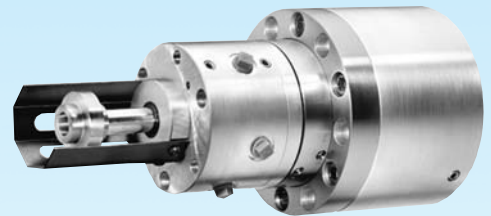

Rework/Repair Services

ITW Workholding offers comprehensive rework/repair services that will bring your existing product back to like new condition. Staffed by technicians that will come to you, as well as a dedicated team within our manufacturing facility, we offer a wide range of services to assist you with your workholding problems.

- Perform On-Site chuck balancing and jaw force testing, on YOUR spindle
- Will visit your facility and do in house preventive maintenance training with your maintenance department, engineers and set-up people to ensure a smooth and seamless start up
- We will rebuild all makes and models of chucks to first class condition and back it up with a 1 year, new equipment warranty, and charge 30% to 50% less than a new chuck
- We can upgrade your existing chuck to include today's most advanced features, and give you a better value for your equipment dollar
- We offer a dedicated manufacturing department, focused on rebuilding and reconditioning your workholding

ITW Workholding Group

WORKHOLDING WORLDWIDE



WORKHOLDING LOCATIONS

N.A. WOODWORTH
 1391 Wheaton, Suite 700
 Troy, MI 48083, USA
 Tel: (+1) 800-544-3823
 Fax: (+1) 248-743-4401
 E-Mail: sales@itworkholding.com

FORKARDT NORTH AMERICA
 1391 Wheaton, Suite 700
 Troy, MI 48083, USA
 Tel: (+1) 800-794-6190
 Fax: (+1) 248-743-4401
 E-Mail: info@forkardtusa.com

BUCK CHUCK
 2155 Traversefield Drive
 Traverse City, MI 49686, USA
 Tel: (+1) 231-995-8312
 Fax: (+1) 231-947-4953
 E-Mail: info@itwbuckchuck.com

FORKARDT DEUTSCHLAND GMBH
 Heinrich-Hertz-Str. 7
 D-40699 Erkrath
 Tel: (+49) 211-25 06-0
 Fax: (+49) 211-25 06-221
 E-Mail: info@forkardt.com

FORKARDT SCHWEIZ AG
 Industriestrasse 3
 CH-8307 Effretikon
 Tel: (+41) 52-3 55331
 Fax: (+41) 52-3 43540
 E-Mail: info-ch@forkardt.com

FORKARDT FRANCE S.A.R.L.
 28 Avenue de Bobigny
 F-93135 Noisy le Sec Cédex
 Tel: (+33) 1-41 83 12 40
 Fax: (+33) 1-48 40 47 59
 E-Mail: forkardt.france@forkardt.com